

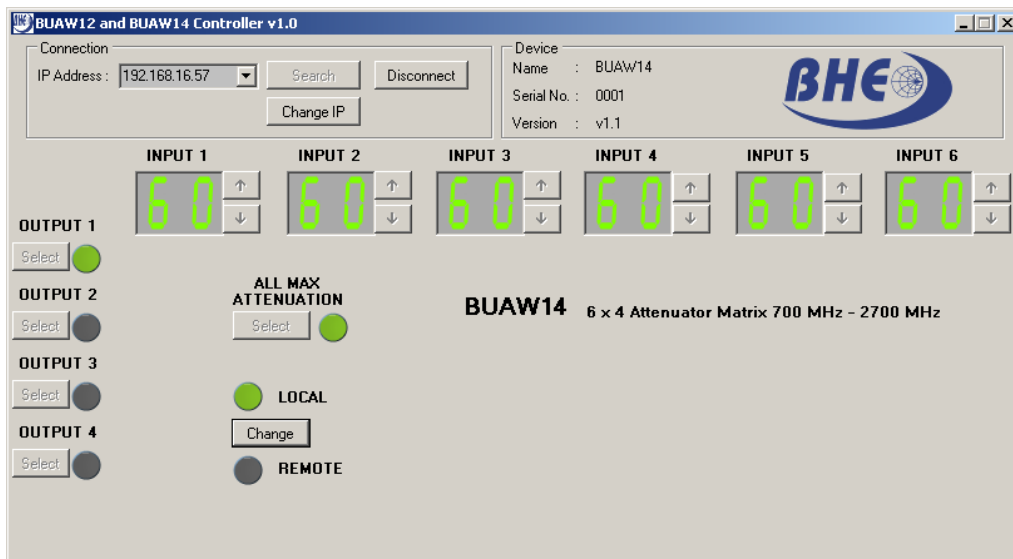

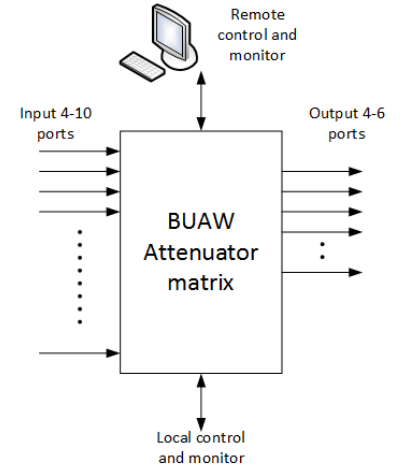





BHE BUAW attenuator matrixes are ideal tools to help mobile operators and radio development teams to test handover and MIMO performances on trial network in laboratory environment to ensure smooth operation. These equipment are special testing devices have multiple input and multiple output ports that covers all mobile communication related frequency bands from 700 MHz to 6000 MHz. The attenuation can be adjusted within wide, 60 dB range in 1 dB steps. High isolation between the RF ports and stable attenuation level provide accurate measurement. Via local or remote control interface users can adjust the attenuation and can direct the signal transmission from input to any of the outputs. Datasheets can be downloaded from www.bhe-mw.eu



BUAW series at a glance

Model	Operation Frequency Range	No of input ports	No of output ports	Minimum Attenuation at 950 MHz	Attenuation Range	Remote Control Interface	Isolation	Construction
BUAW12	700 – 2700 MHz	6	6	50 dB	60 dB	Ethernet	> 50 dB	19" wide, 4U high
BUAW13	700 – 2700 MHz	4	4	35 dB	60 dB	Ethernet	> 50 dB	19" wide, 4U high
BUAW14	700 - 2700 MHz	6	4	35 dB	60 dB	Ethernet	> 50 dB	19" wide, 4U high
BUAW15	700 - 2700 MHz	8	6	40 dB	60 dB	Ethernet	> 50 dB	19" wide, 4U high
BUAW16	700 - 2700 MHz	10	6	45 dB	60 dB	Ethernet	> 50 dB	19" wide, 4U high
BUAW20	700 – 6000 MHz	8	4	40 dB	60 dB	Ethernet	> 50 dB	19" wide, 4U high

<p>BUAW12</p> 	<ul style="list-style-type: none"> ➤ 6 input / 6 output matrix ➤ 50 dB minimum attenuation ➤ 30 dBm input power handling ➤ Ethernet control interface
 <p style="text-align: center;">BUAW13</p>	<ul style="list-style-type: none"> ➤ 4 input / 4 output matrix ➤ 45 dB minimum attenuation ➤ 35 dBm input power handling ➤ Ethernet control interface

<p>BUAW14</p> 	<ul style="list-style-type: none"> ➤ 6 input / 4 output matrix ➤ 35 dB minimum attenuation ➤ 35 dBm input power handling ➤ Ethernet control interface
 <p>BUAW15</p>	<ul style="list-style-type: none"> ➤ 8 input / 6 output matrix ➤ 40 dB minimum attenuation ➤ 35 dBm input power handling ➤ Ethernet control interface
<p>BUAW16</p> 	<ul style="list-style-type: none"> ➤ 10 input / 6 output matrix ➤ 45 dB minimum attenuation ➤ 35 dBm input power handling ➤ Ethernet control interface
 <p>BUAW20</p>	<ul style="list-style-type: none"> ➤ 8 input / 4 output matrix ➤ 40 dB minimum attenuation ➤ 35 dBm input power handling ➤ Ethernet control interface

For further information please contact us sales@bhe-mw.eu.